

# PRODUCT DATA SHEET

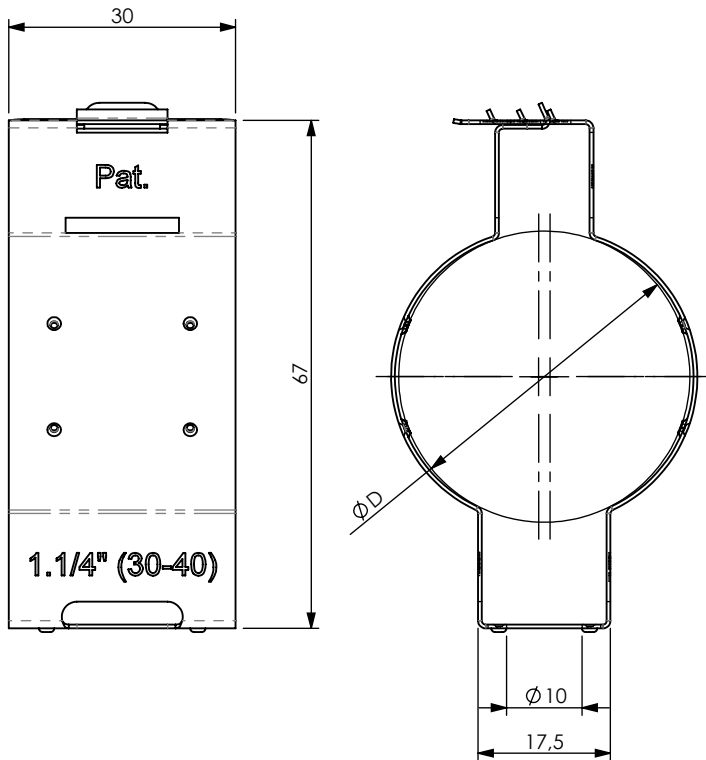

## A) SPECIFICATIONS

Click Collars for Cables and Pipes.  
Ratchet-tightening and opening by hand without tool.  
Monoblock body made of flexible Stainless Steel.

## B) DELIVERY MODALITIES

Packing in boxes. Label indicating: product code, article, quantity, production batch, FIMO logo and figure. ( Customer code on request ).

## C) MOUNTING INSTRUCTIONS

On request

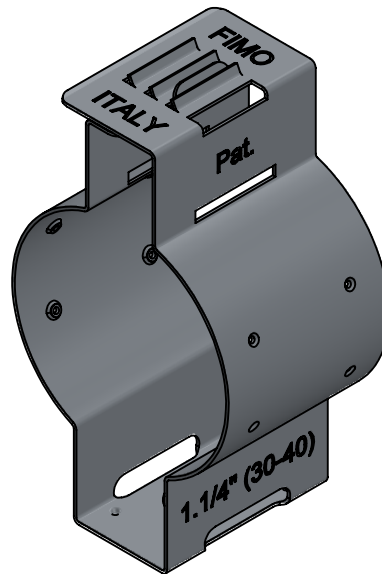

code	<b>6120100040</b>
article	SCC 40

<b>D</b>		
30-40	100	0.0221kg

RI	DATE	DR	DATE	AP	Description:  <b>SCC 40 = click collar for cable 1.1/4"</b>
02					
01					
00	26/01/2015	E.B.	26/01/2015	A.V.	
1 <sup>ST</sup> EMISSION					
					Use: Security system for radiating cables on steel ropes